

SYNERGY 131

Triple Assembly

Includes:

- (1) Triple 10 Unit
- (2) S10 Side Panels
- (2) S10 Drop Down Doors

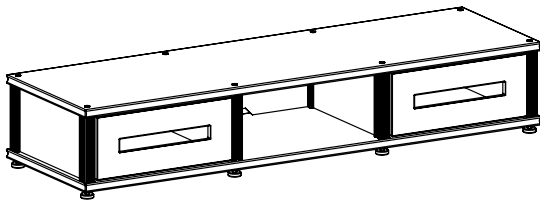

BEFORE YOU BEGIN:

- Unpack all parts before beginning and refer to the drawing below.
- Shelf pegs and door hinges must slide into the channels of the post in the correct order. They cannot be removed individually without disassembling the whole unit.

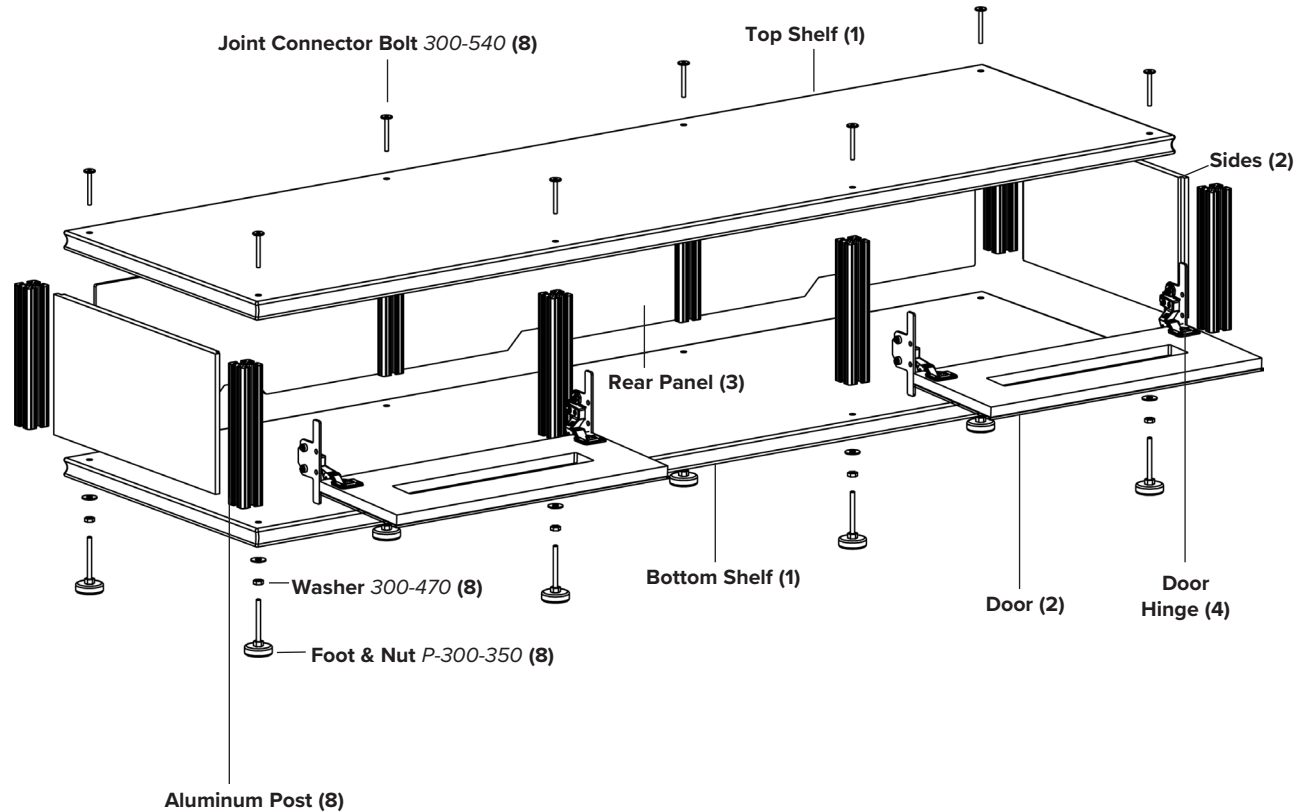

Limited Warranty

For five full years Salamander Designs Ltd will repair or replace, at our option, any product defective in materials or craftsmanship. Salamander Designs Ltd. will not be responsible for any damage to or destruction of other equipment consequential to our equipment failure. Defective product must be given Return Authorization and is to be returned to the factory prepaid, in the original carton and packing material. Any damage incurred in a shipment not in original packaging shall be the responsibility of the owner. Warranty repairs will be returned prepaid, via UPS within the continental U.S.A. only.

Salamander Designs Ltd. 800-535-5659 • www.SalamanderDesigns.com

©2024 Salamander Designs Ltd. ® Synergy System, Patented.

1 Connect Posts to Bottom Shelf



WARNING: Tighten by screwing the leveler foot NOT the post.

A. Square Post

Square the post to the bottom shelf.

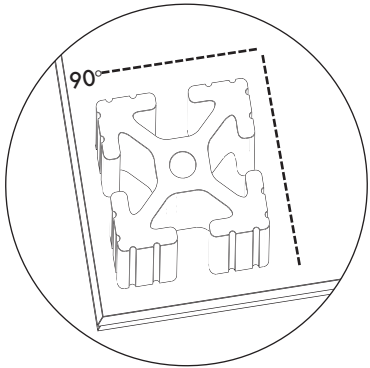

B. Connect Post

Screw foot with metal washer through bottom shelf and onto the end of each extruded post. Hand tighten fully and use wrench to tighten nut onto underside of shelf.

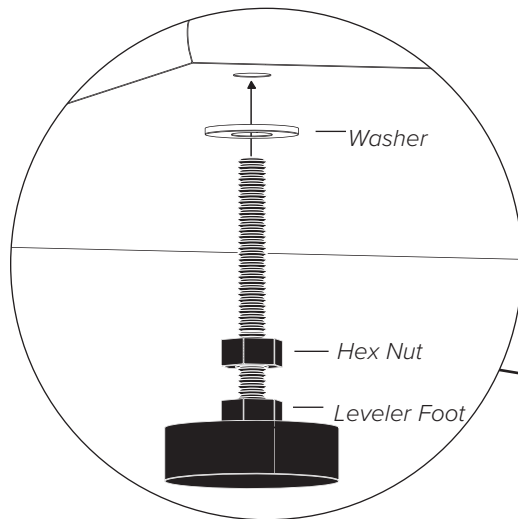

2 Insert Rear Panels

Carefully slide the three rear panels down center channel of rear posts. Be sure the posts are square to the bottom shelf to prevent any damage to rear panels.

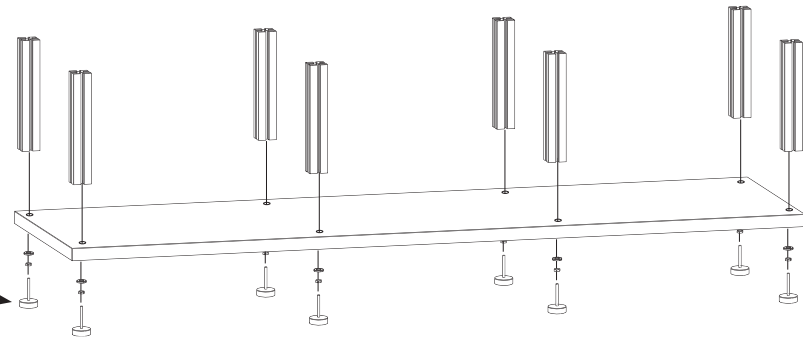
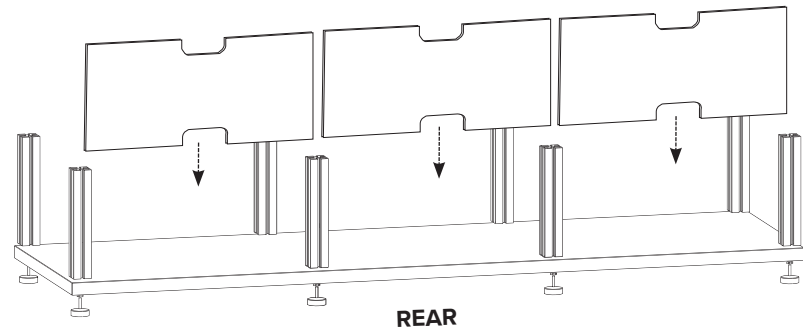

3 Attach Doors

A. Align the double weld nut, adapter bracket, and provided 1/4-20 x 0.5" screws as shown above. Then loosely thread the screws through the adapter bracket and into the weld nut.

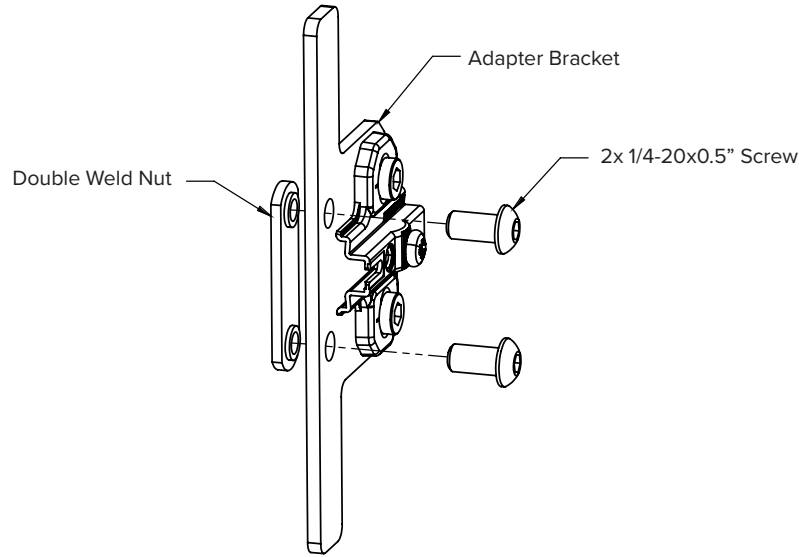

B. On each side of the bay the drop down door will be installed in, slide the double weld nut of the adapter plate assembly into the inner slot of the extrusions as shown. Once the adapter plate assembly is resting on the bottom, tighten the screws to secure the assemblies in place.

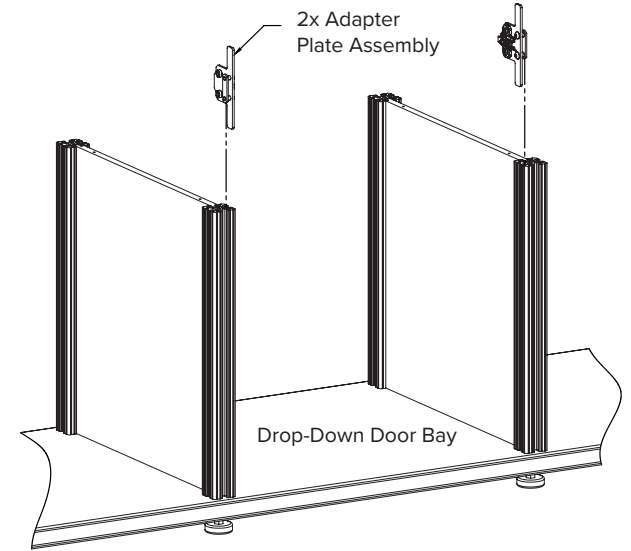

C. Assemble the provided hinges onto the drop-down door using the provided #5 x 5/8" wood screws as shown, both sides.

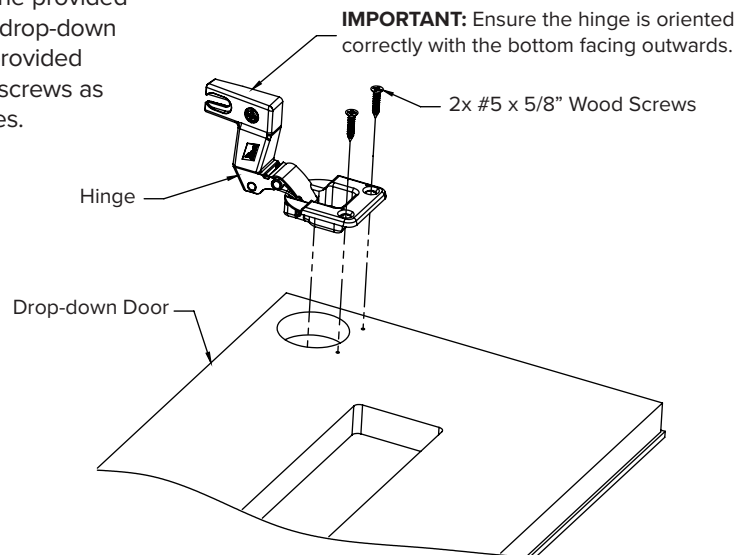

D. Slide the hinges of the door assembly into the adapter plate assembly as shown and tighten the center screw to secure. To adjust the door loosen the center screw and slide forward or backwards as needed.

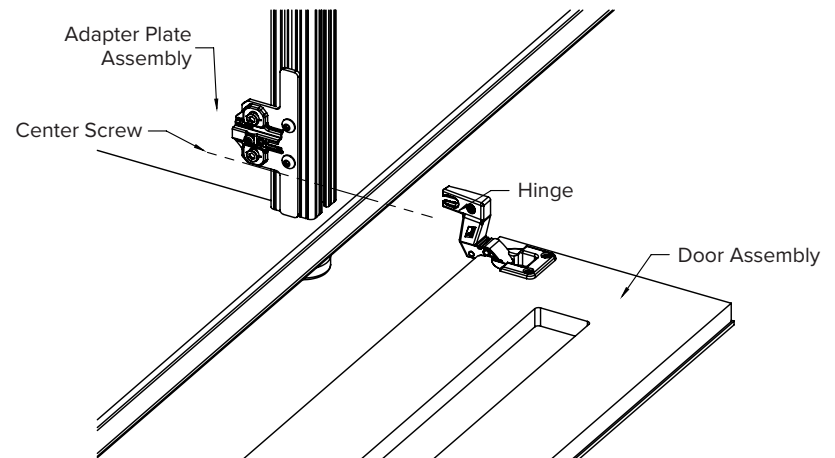

3 Attach Doors

E. Assemble shelf peg loosely and slide down one of the same extrusions slots as the hinge brackets. At about 7" from the base tighten and secure the shelf peg. Apply the clear square rubber door pad to the outside of the shelf peg and verify the drop-down door rests on it in the closed position.

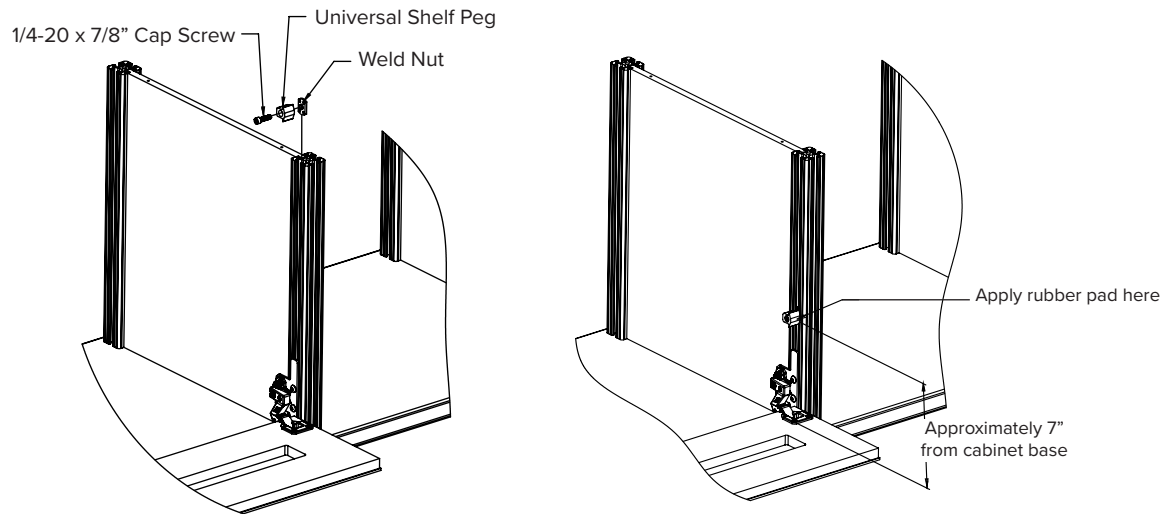

4 Insert Side Panels

Carefully slide side panels down center channel of outside posts. Be sure the posts are square to the bottom shelf to prevent any damage to side panels.

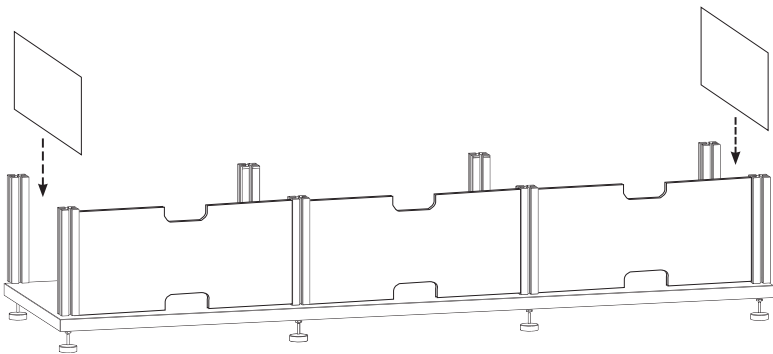

5 Secure Top

Secure top with the 8 connector bolts to complete installation.

