

SYNERGY 133

Triple Assembly

Includes:

- (1) Triple 10 Unit
- (2) S10 Side Panels
- (3) S10 Doors

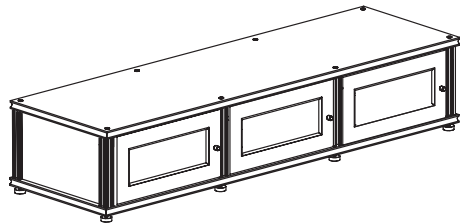

BEFORE YOU BEGIN:

- Unpack all parts before beginning and refer to the drawing below.
- Shelf pegs and door hinges must slide into the channels of the post in the correct order. They cannot be removed individually without disassembling the whole unit.

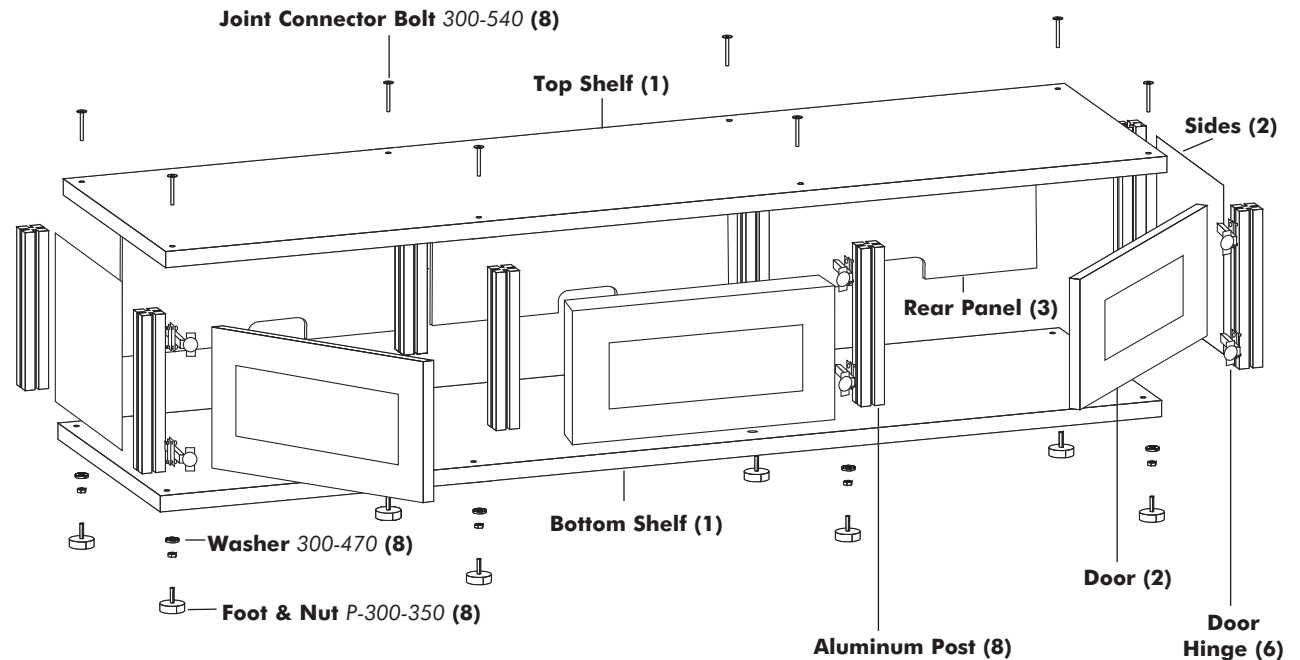

Limited Warranty

For five full years Salamander Designs Ltd will repair or replace, at our option, any product defective in materials or craftsmanship. Salamander Designs Ltd. will not be responsible for any damage to or destruction of other equipment consequential to our equipment failure. Defective product must be given Return Authorization and is to be returned to the factory prepaid, in the original carton and packing material. Any damage incurred in a shipment not in original packaging shall be the responsibility of the owner. Warranty repairs will be returned prepaid, via UPS within the continental U.S.A. only.

Salamander Designs Ltd. 800-535-5659 • www.SalamanderDesigns.com

©2005 Salamander Designs Ltd. ® Synergy System, Patented.

Doc No. 501-065 / v6.18 133 - 1 of 4

1 Connect Posts to Bottom Shelf



WARNING: Tighten by screwing the leveler foot NOT the post.

A. Square Post

Square the post to the bottom shelf.

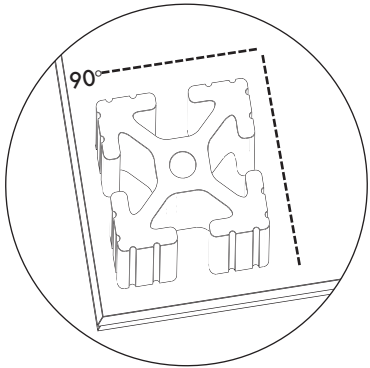

B. Connect Post

Screw foot with metal washer through bottom shelf and onto the end of each extruded post. Hand tighten fully and use wrench to tighten nut onto underside of shelf.

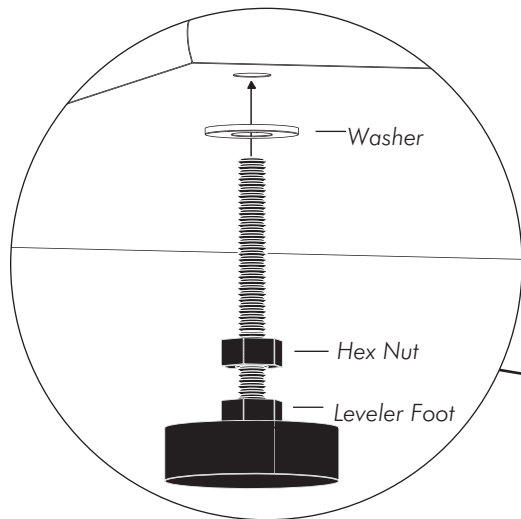

2 Insert Rear Panels

Carefully slide the three rear panels down center channel of rear posts. Be sure the posts are square to the bottom shelf to prevent any damage to rear panels.

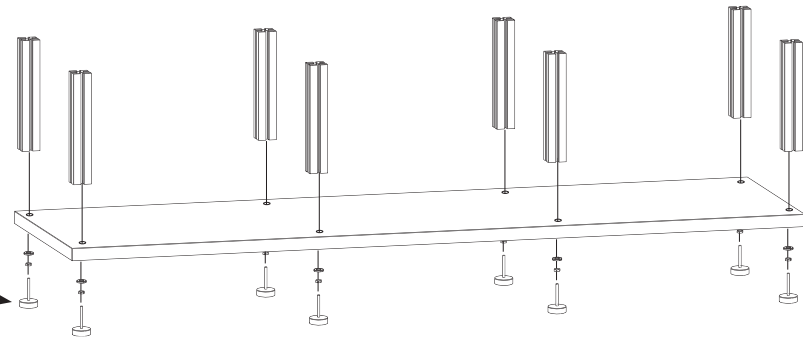
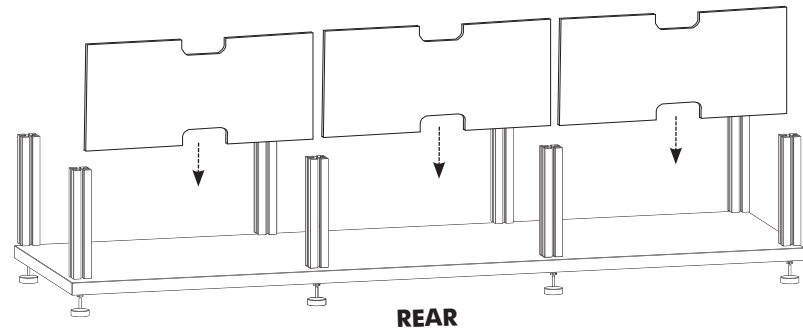

3 Attach Doors

A. Attach Hinges to Door Frames

Insert the hinges into the corresponding holes on the doors. Turn the screws 1/4 turn to the right to lock hinges in place. **NOTE: Do not over tighten or the hinge will break.**

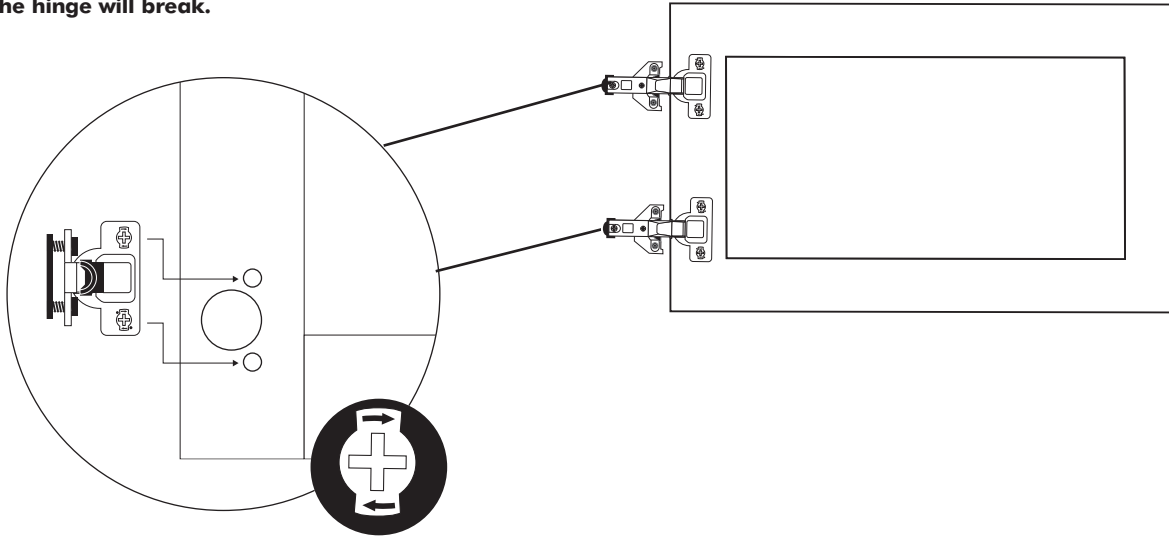

Note: The hinge can be separated by pulling the black tab and pulling apart the hinge from the hinge base. Separated hinges snap back together.

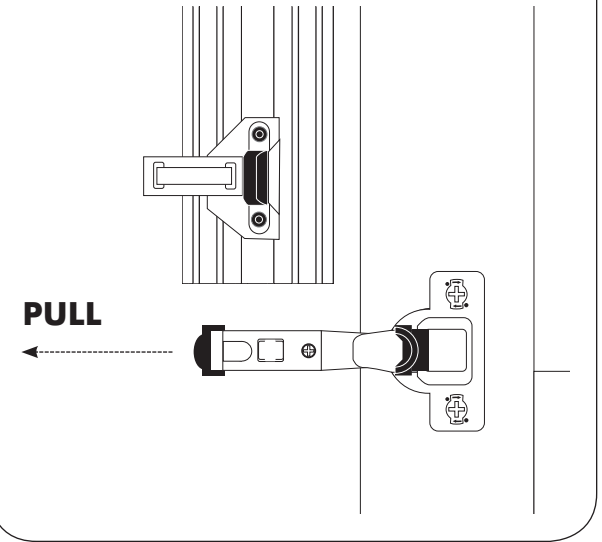

B. Adjust Clearance

Doors should be 1/8" above the bottom shelf before fully tightening hinges to post. Use the wrench thickness as a guide for the bottom gap. Secure hinges in place with hex key.

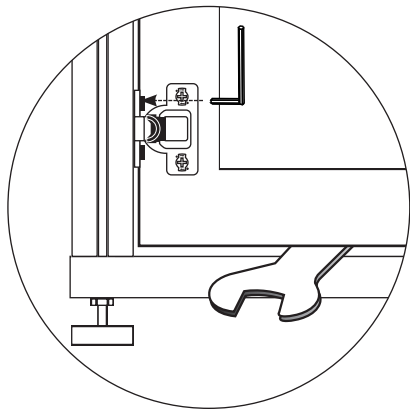

C. Rubber Stops

Attach the rubber stops to the inside of the door frame where it hits the shelf pegs.

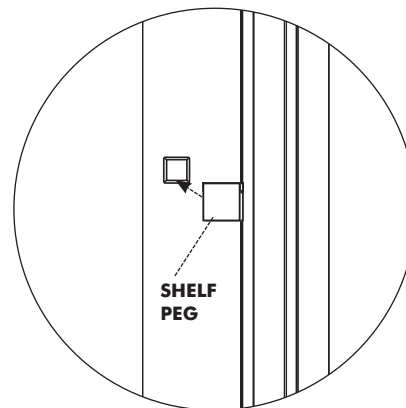

D. Door Pull

Screw the Door Pull into place.

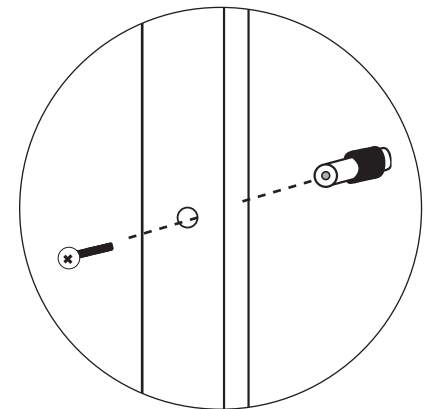

4 Insert Side Panels

Carefully slide side panels down center channel of outside posts. Be sure the posts are square to the bottom shelf to prevent any damage to side panels.

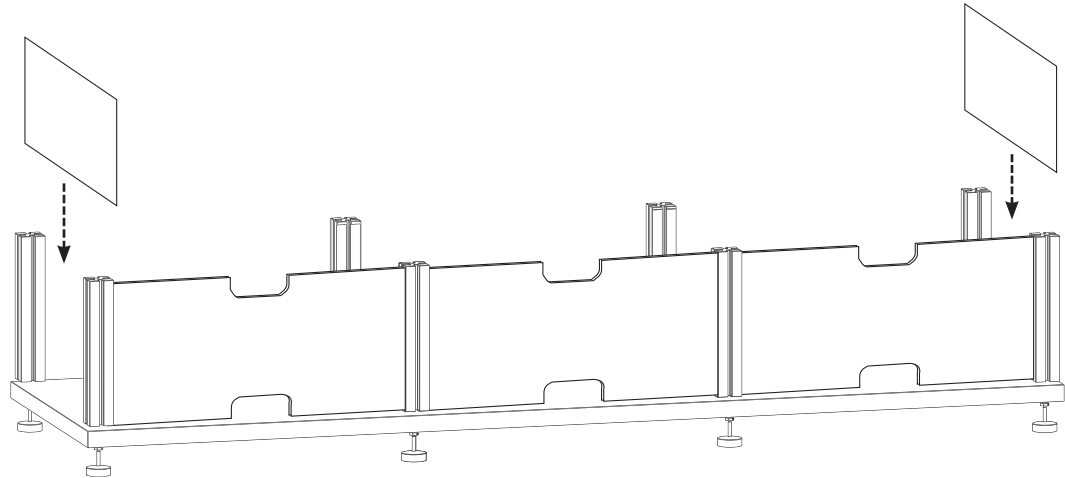

5 Secure Top

Secure top with the 8 connector bolts to complete installation.

